

Note: drawing could be diminished.
Original scale 1:100 and format A1

0m 10m 20m 30m 40m

A

B

C

D

E

F

G

H

I

J

K

A

B

C

D

E

F

G

H

I

J

K

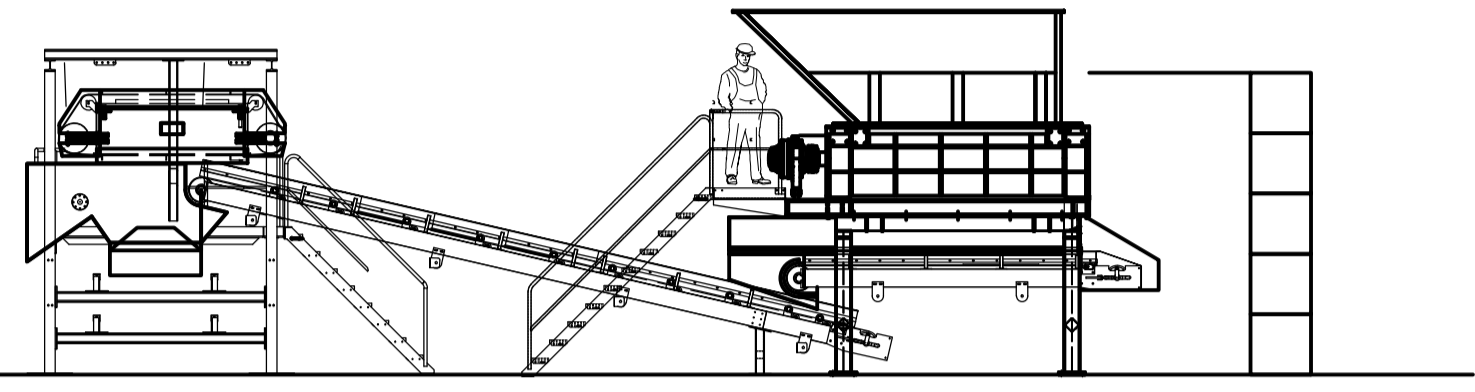
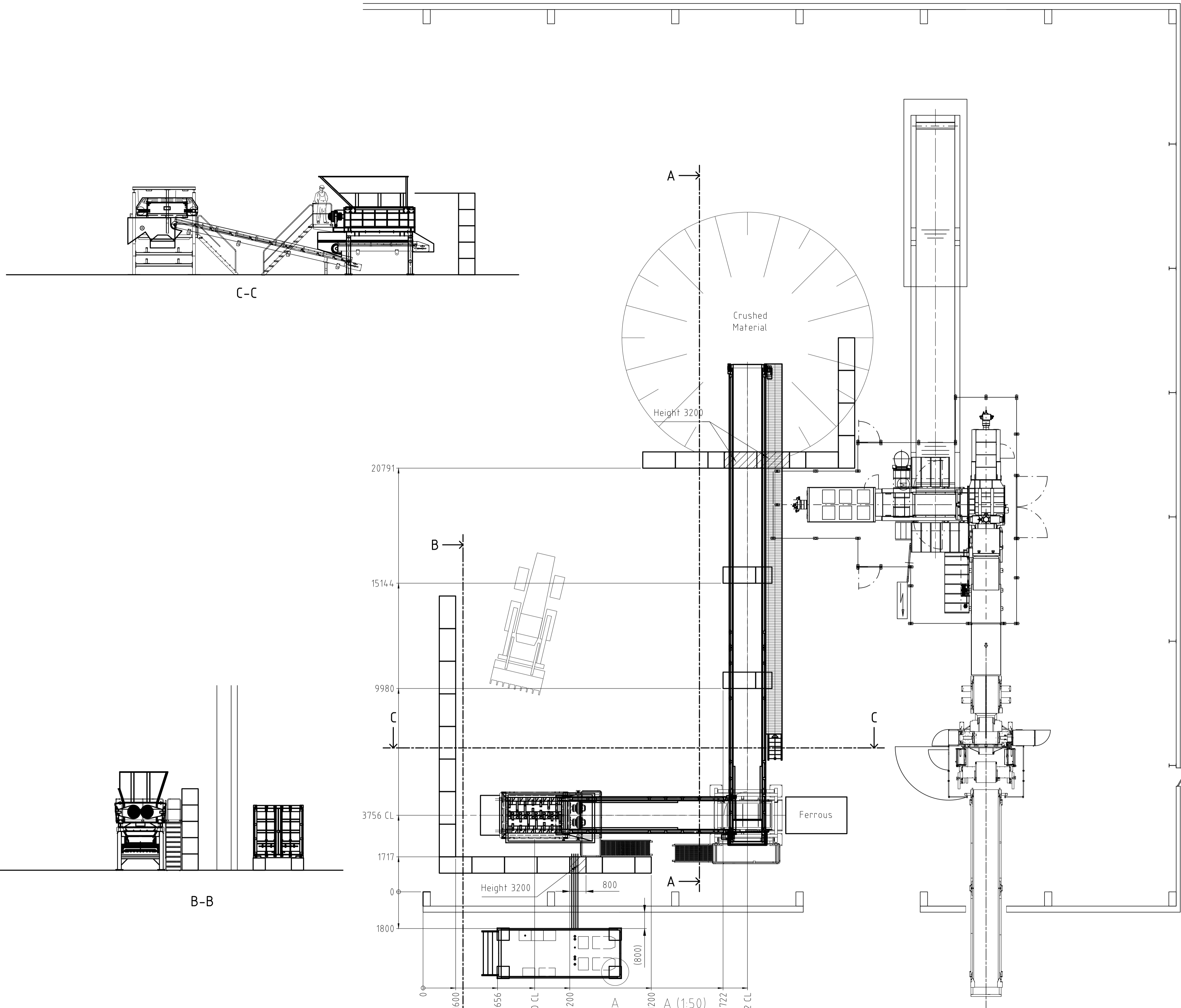

C-C

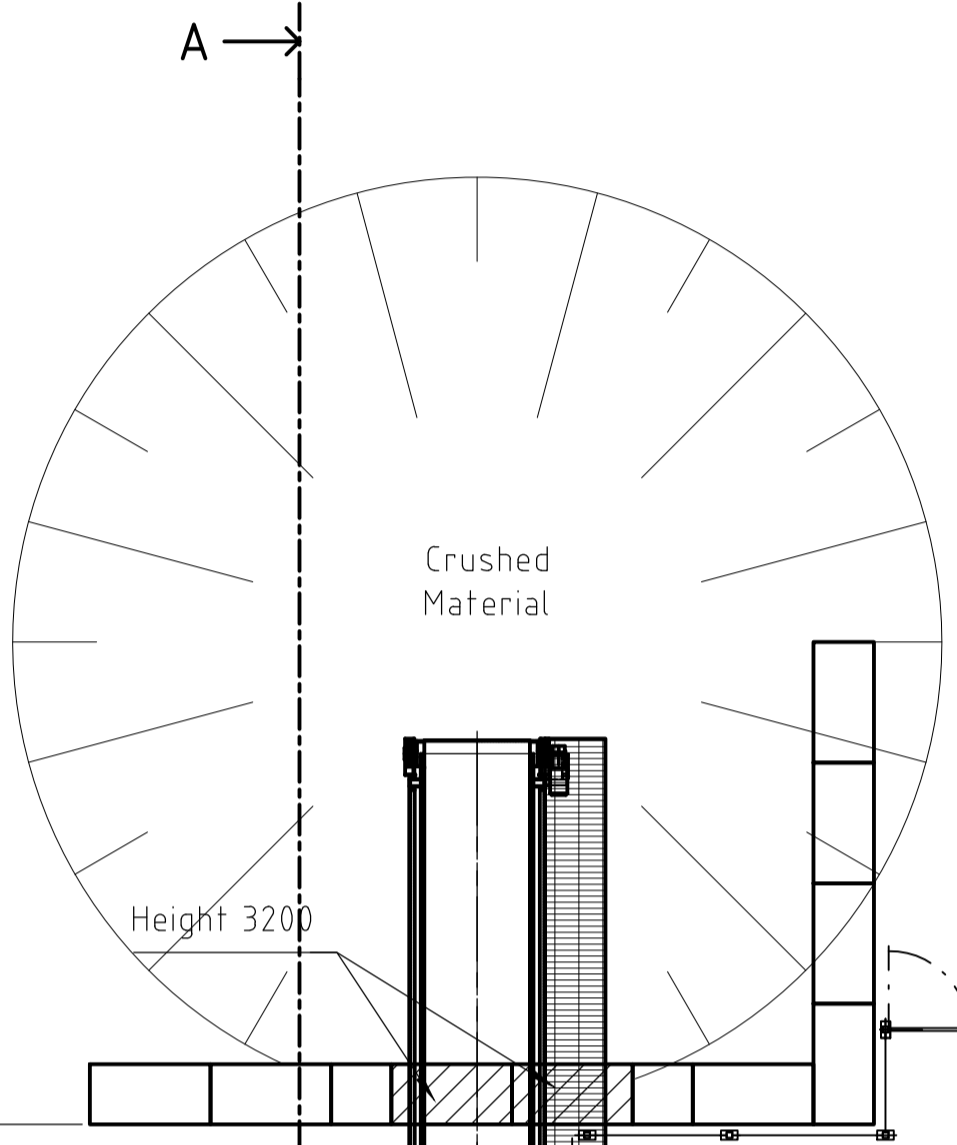

A

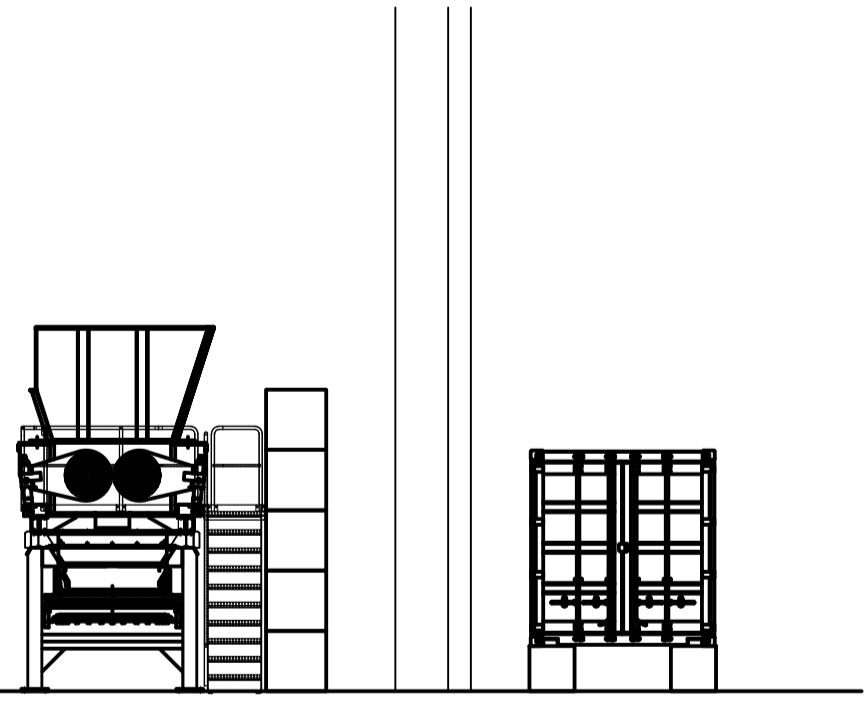

B-B

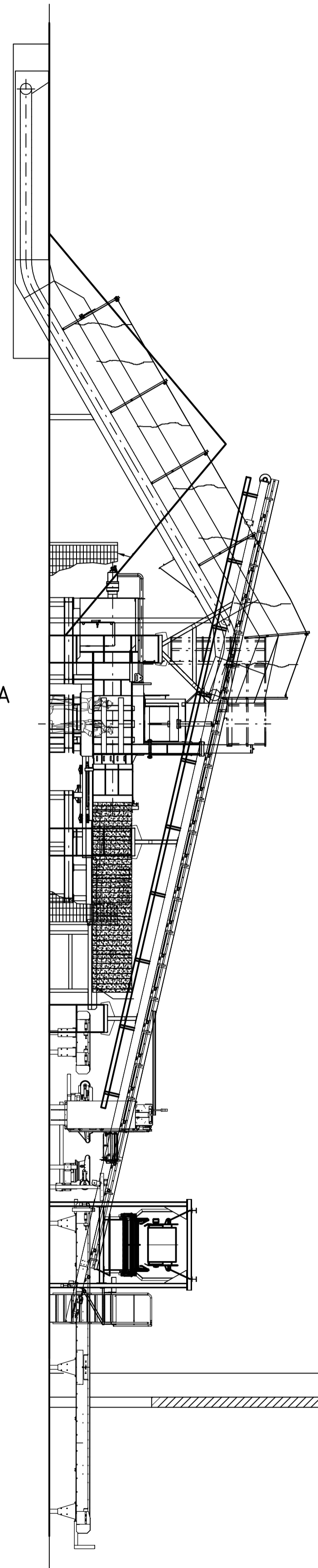

A-A

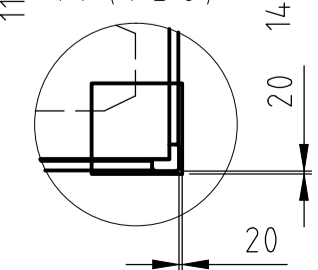
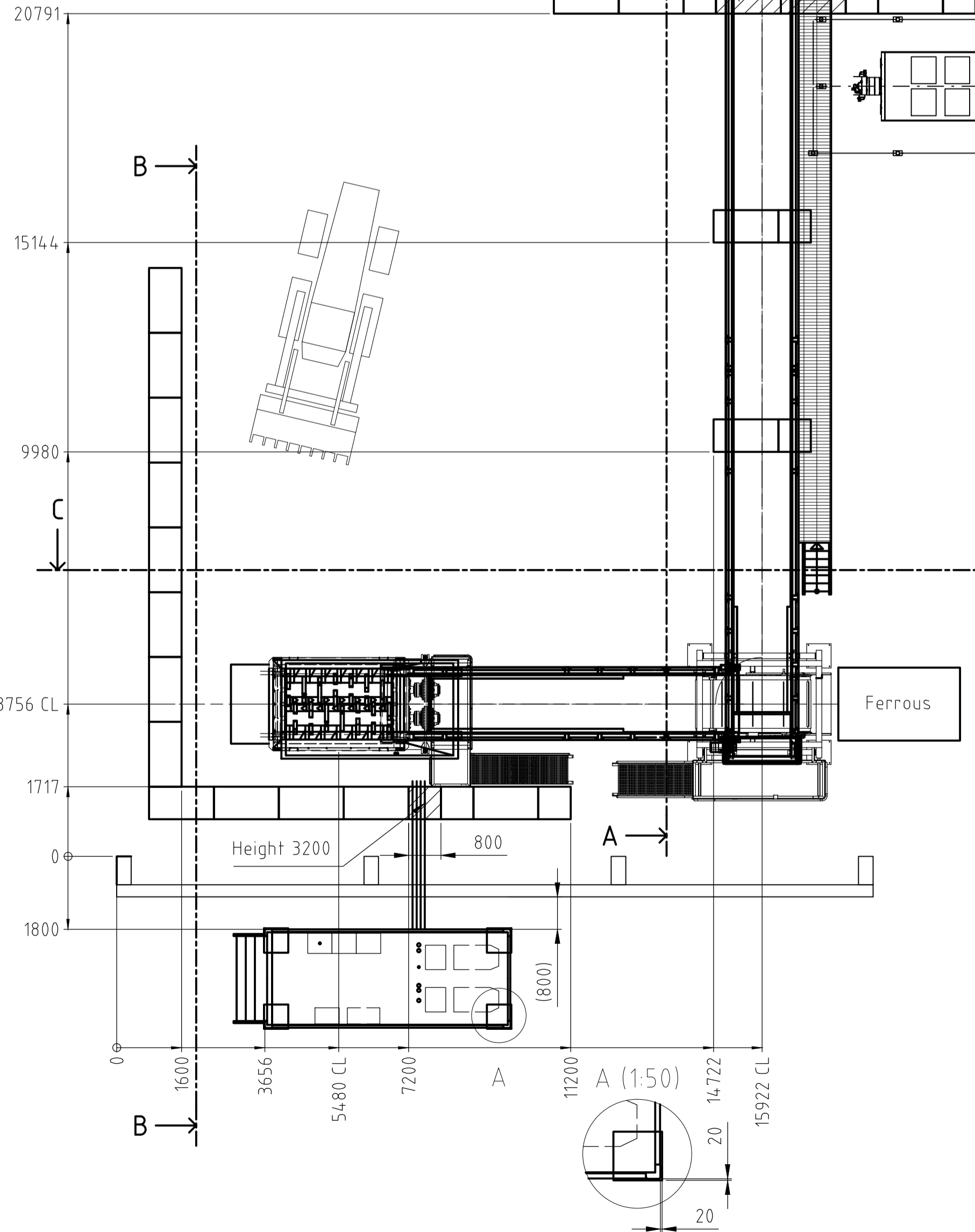

A (1:50)

This drawing is a private and confidential communication and the property of IQOR. It must not be copied or loaned without our consent.

	Design by	Date	Notice	Part No.
	MS	2014-03-18		
Drawn by	Replaces	P1095 Boomeco Waste Treatment Plant Layout		
Checked by	Replaced by	Drawing No. 14.0318-01		
Scale	1:100	Rev.		

Fredrikbergsgatan 15 Tel: +46 40 680 89 99
SE-212 11 Halmstad, Sweden Fax: +46 40 680 89 99